

PLUG-IN FOR VERTICAL OR 90° MOUNTING SCREW TERMINAL 5MM PITCH

- FEATURES:**
- 2-12 pole interlocking
 - Plug in
 - Test probe facility
 - Dual horizontal or vertical mounting
 - Moulded in green UL94-V0 flame retardant glass filled polyester
 - Wire protector terminals
 - 1.5mm² cable entry
 - UL approved and CSA applied
 - Captive screws
 - Rating: 10A/380V

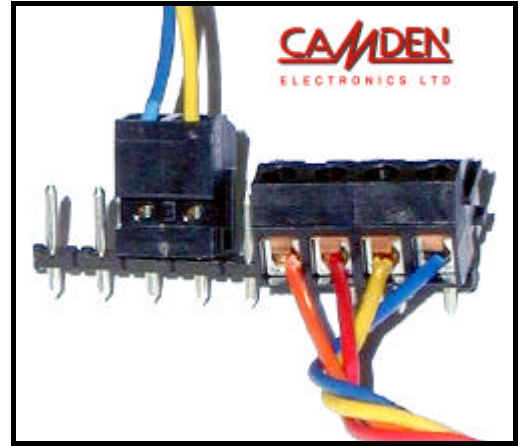
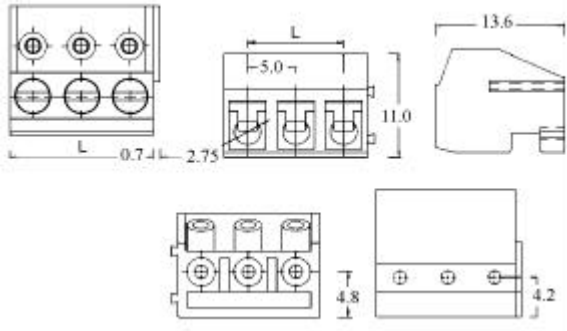

Part Number	Type	Length
CTB1300/2	2 Way	10mm
CTB1300/3	3 Way	15mm

PIN STRIP HEADER, 5MM PITCH, 24 PIN



- FEATURES:**
- Supplied in 24 way
 - Easily cut to required length
 - Flame retardant Polyester material
 - Anti solder wicking
 - Guided pin alignment
 - Can be supplied pre-cut
 - Single pin available (CTB1300P)
 - Rating: 10A/380V

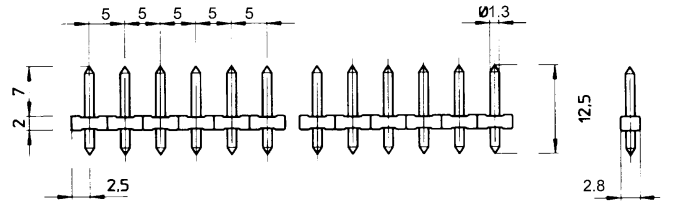

Part Number	Poles
CTB1300P24	24

PLUG-IN SCREW CONNECTORS

- FEATURES:**
- Bench made wiring
 - No wiring errors
 - Ease of systems service
 - Ease of handling in tight spots
 - Rating: 6A/300V
 - PCB hole size: F 1.30mm



Plug

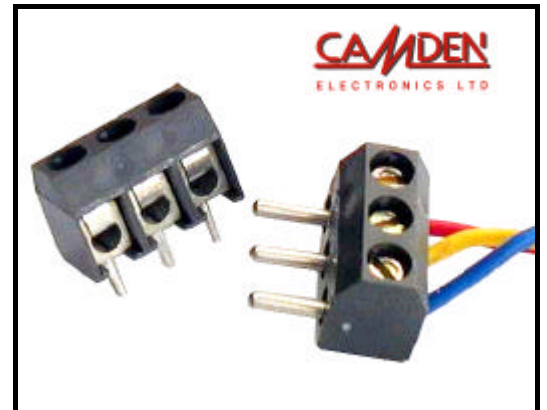
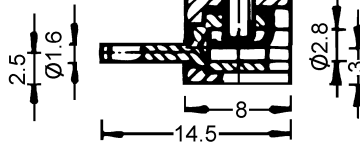

PLUG

Part Number	Poles
951SVDS-2	2
951SVDS-3	3

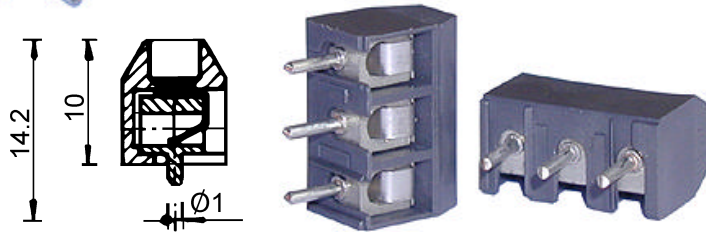

SOCKET

Part Number	Poles
950FB-2	2
950FB-3	3

PLUG-IN FOR VERTICAL OR 90° MOUNTING RISING CLAMP TERMINAL

- FEATURES:**
- Unique 36 pole strip
 - Easily cut to required number of poles
 - Can be supplied pre-cut to specified number of poles
 - Dual horizontal or vertical mounting
 - Moulded in grey UL94-V0 flame retardant Lexan
 - Professional rising clamp terminals
 - 4mm² cable entry
 - UL & CE approved and cUL applied
 - Optional polarising clips
 - Anti solder wicking
 - Guided pin alignment
 - Captive screws
 - Rating: 13.5A/380V
 - PCB hole size: F 1.3mm



FEMALE

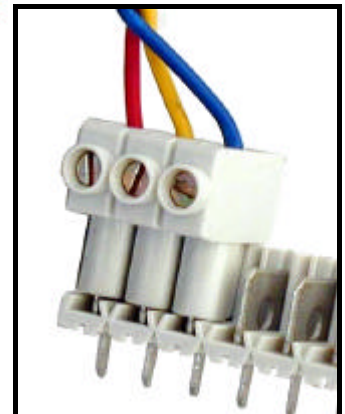
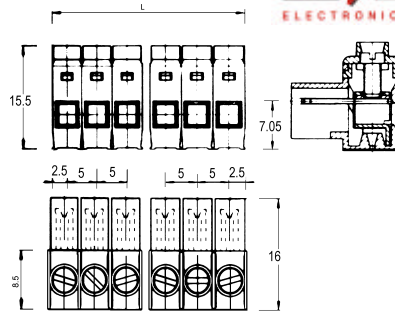

Part Number	Style	Poles
CTB7300/36F	Female	36
CTB7300/36M	Male	36



MALE

